

Fabric Ducting and Diffusers

SCIENCE

Smart





ABOUT US

We are a medium large Czech company manufacturing first-class textile ducting and diffusers for air transportation and distribution. We do not manufacture ducting by the meter, but provide custom-made solutions. Our work is based on high technical quality and knowledge of airflow. Our company is located in the small industrial city of Hlinsko in the middle of the Czechia. From there, and from our subsidiaries in **China** and **Mexico**, we send our products to tens of countries on all continents. We work closely with a network of trained sales agents, who are part of the unit called the **“Příhoda Family”**. The company, which was established in **1994**, is still owned and managed by its founder **Zdeněk Příhoda**.

PHILOSOPHY

**RELIABILITY** Delivering first-class quality by the confirmed deadlines.

**INNOVATION ABILITY** Solving special customer requirements and expanding the possibilities of our textile diffusers.

**RESPONSIBILITY** Accepting full responsibility for our decisions, products and services.

**PARTNERSHIP** Building long-term partnerships with our customers, suppliers and colleagues, based on mutual trust.

**AMBITION** Being a leader on the world markets in our specific field.

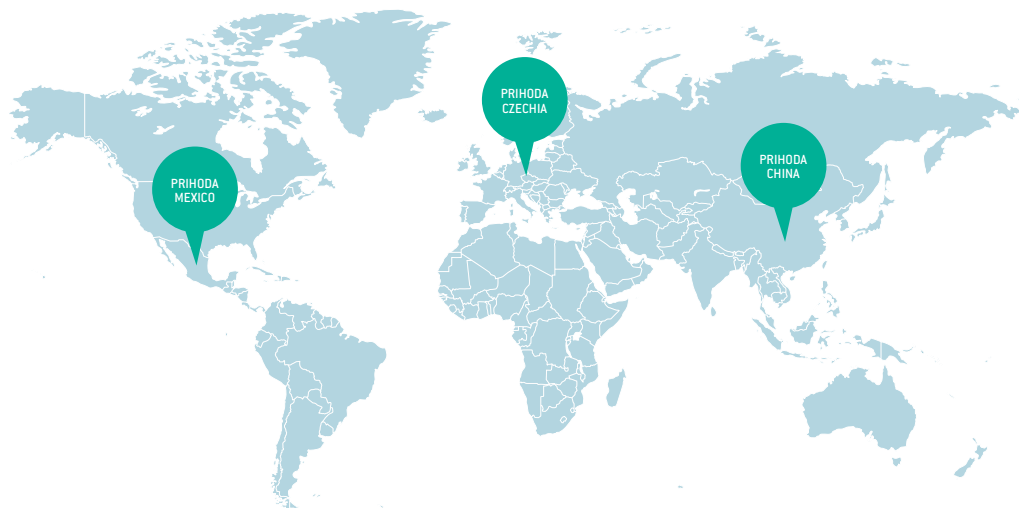

**1**  
centre of the company  
design and development

**3**  
production plants

**25+**  
years on the  
market

**70+**  
countries, to which our  
products are exported

**200+**  
employees

**70 000+**  
implemented orders

**10 000 000+**  
m<sup>2</sup> of sewn diffusers

## THE ART AND SCIENCE OF AIR DISTRIBUTION

Our work involves a thorough knowledge of how air flows in ducts and in space. We customize our fabric diffusers based on a given space, making sure we satisfy the requirements of our customers. They can be supplied with any graphic motif and in any colour.

### Our Innovations and Specialities

We are experts in airflow in ducting and in the space. We have introduced several technical innovations and improvements on the market. We are the owners of several patents (hereinafter referred to as “PP” or “Patent Příhoda”). In many of the below described cases we are still the only company that supplies the stated devices.

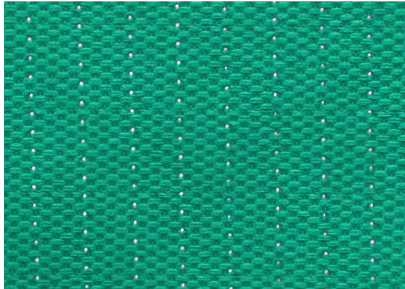

#### MICROPERFORATION (PP)

Directional holes with a diameter less than the thickness of the fabric are a design patented by Příhoda s.r.o. They provide a number of advantages when used for surface air supply at low speed.

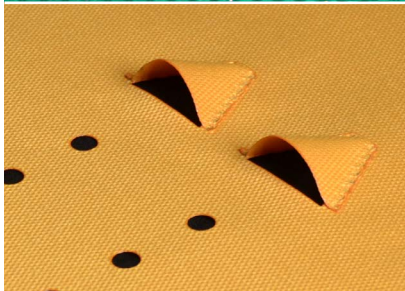

#### TEXTILE AIR CONTROL POCKETS (PP)

Fabric pockets are used for aligning deflection of the air coming from the perforation. The solution is based on combining two airflows of a similar momentum. The flow from the last hole in the row is directed under a certain angle using a fabric pocket, thus aligning the air deflection from the perforation.

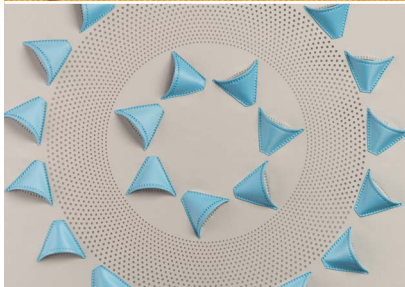

#### OUR SPECIALITIES

#### SQUAIRETEX® (PP)

Flat diffusers into false ceilings do not have to be made of sheet metal; our SquAireTex range is a fully-fledged alternative. Moreover, you can choose any colour or motif.



#### SPIRAL REINFORCEMENT HELIX (PP)

A metal spiral covered in fabric is inserted inside of the diffuser. It maintains permanently cylindrical shape and the fabric stretched. The necessary gradient of the spiral is ensured by longitudinal textile straps. The spiral can be easily disassembled for maintenance purposes. It is also made for a majority fitting types.



#### FABRIC NOZZLES

Ultrasound-connected nozzles 20 to 40 mm in diameter are a great way of achieving greater flow range. Compared to plastic nozzles they are significantly more fire resistant and stay on the duct better.



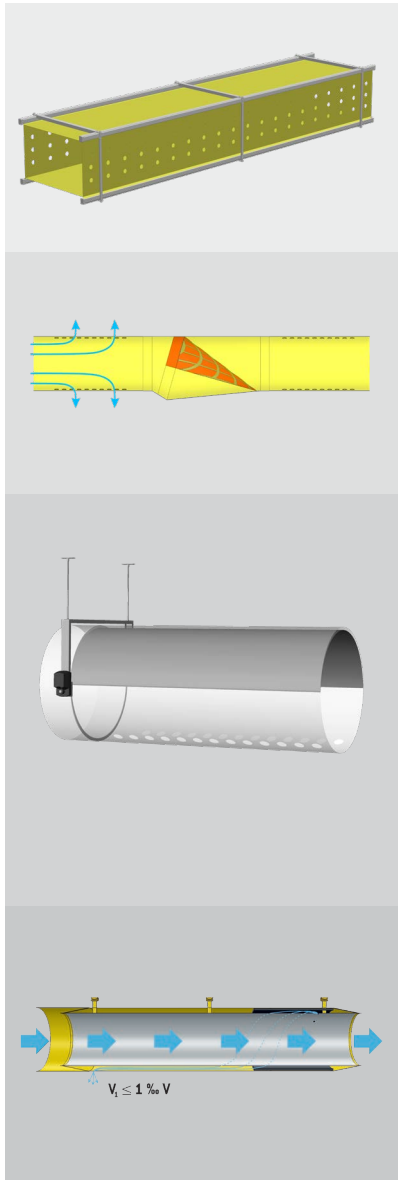

**OUR SPECIALTIES**

**NEGATIVE PRESSURE (EXHAUST) DUCTING (PP)**

Our patented tensioning structure enables us to manufacture rectangular-section ducts which can also be used for exhausting.

**FABRIC SHUTTER (PP)**

The first fabric shutter on the market is used to temporarily close off a branch or part of a duct.

**MEMBRANE DIFFUSER**

It is a diffuser that combines two completely different air distribution methods. The membrane, made of a light and airtight fabric is horizontally sewn into the centre of the diffuser. It alternately covers its one or the other half. When heated, the membrane covers the upper half and the air leaves in the downward direction directly to the operation zone. When cooled, the membrane covers the bottom half. Cool air passes through the upper half and slowly, without any unpleasant draft, flows to the operation zone.

**INSULATED AND DOUBLE DUCTS (PP)**

To prevent condensation from forming on the surface of the duct and to cut heat or cooling loss, we manufacture ducts that are either insulated or double with an intermediate layer of air.

**Prihoda Art**

Our fabric colouring technology gives our textile diffusers a new aesthetic dimension. They can become an interesting part of every interior. We can produce fabric diffusers and air ducting in any Pantone colour, with any pattern, photograph, picture, logo or sign, regardless of how complex they are.

DESIGN



# REASONS FOR FABRIC

The future belongs to fabric diffusers and ducting. Compared to the traditional sheet metal ducting, they certainly have economic, technical, hygienic, environmental and aesthetic advantages. Příhoda s.r.o. belongs among the top and largest manufacturers in the world.

ADVANTAGES

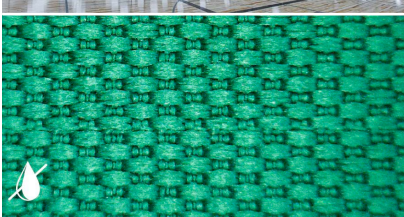
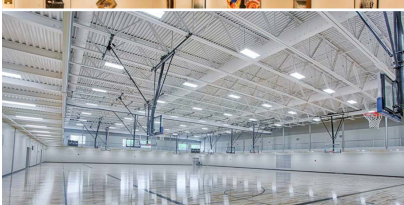
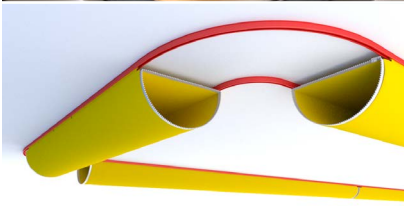
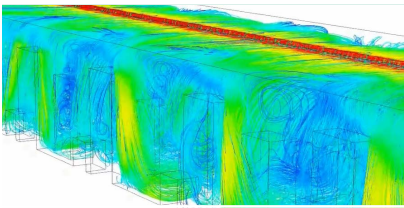

TEXTILE DUCTING



### AIRFLOW BASED ON GIVEN REQUIREMENTS

The custom-designed combination of a large number of distribution elements provides the required, usually even, flow of air through an area.

### FLAWLESS CLEANING AND MAINTENANCE

It is the only ducting system that can be thoroughly cleaned by washing in a washer with an optional use of a disinfection.

### FAST INSTALLATION

Installation of fabric ducting is very easy and fast. It will take you only 20% of the time you would need for the assembly of sheet metal ducting.

### APPEARANCE UPON REQUEST

With the Příhoda ART technology, you can choose any colour or graphic motif. Your ducting can thus become an advertisement surface or it can completely blend in with the given interior.

### INVESTMENT SAVINGS

The traditional ducting grilles are not necessary since our products already incorporate customized distribution elements, insulation or noise absorbers. Transportation is also cheap thanks to the low weight of our products and the fact that they can be folded into small boxes.

### LOW WEIGHT

Textile diffusers and ducting weight less than 5% in comparison with the weight of sheet metal ducting. They can be easily handled and they represent a minimal load for roof structures.

### CONDENSATION FREE

Use of permeable fabric eliminates the risk of water condensation on the surface of the ducting.

SHEET METAL DUCTING



### UNEVEN AIR DISTRIBUTION

Air is supplied through just a few outlets, which often creates drafts in some areas and insufficient ventilation in other areas.

### EXPENSIVE MAINTENANCE

Cannot be 100% cleaned, particularly when it comes to more complex distribution lines. Maintenance is extremely expensive and time consuming.

### DEMANDING INSTALLATION

Time consuming and technically demanding installation of heavy metal ducts.

### UNIFIED APPEARANCE

Cold and boring appearance with a small possibility of a change.

### EXPENSIVE IMPLEMENTATION

High cost of individual distribution elements, expensive installation and putting into operation.

### HIGH WEIGHT

High weight complicates handling and transports of these products and puts a heavy load on building roof structures.

### CONDENSATION RISK

Condensation occurs and the ducting has to be insulated.

“We feel responsible for our products and customers can contact us and our representatives at any time during the given product lifespan”

Zdeněk Příhoda



REALISATION

## DESIGN

A team of experienced technicians uses unique Air Tailor software to create a custom-made design for air distribution according to the customer's wishes and the layout of the area. We consider unusual requirements a challenge. We have a dedicated development department, which is capable of inventing and testing revolutionary solutions, as is confirmed by the number of patents we own. Each of our designs is discussed in detail with the customer and is subject his approval.

## MANUFACTURE

Organisation of work in work groups increases motivation and personal responsibility for quality. The fine-tuned quality control system ensures 100% inspection of textile parts and installation materials before the contract is dispatched.

## DELIVERY

We deliver over 6,000 contracts to 70 countries worldwide every year and 99% of these contracts leave on the exact deadline we confirmed. We work with professional transportation companies and we monitor the consignment until it is delivered to the customer.

## HELP DURING INSTALLATION

The customer receives detailed printed instructions, with plans of the entire system and important details, with each contract. We have also executed animated instructions, which can be simply downloaded to a mobile phone through the QR code given in the printed instructions, to ensure easier comprehension of the installation process. Our customer support department is always prepared to consult problems during installation and recommend the correct procedure.

## MAINTENANCE

The fabric ducting and diffusers can be cleaned perfectly by laundering in a washing machine. The frequency of maintenance depends on the environment and on local hygiene standards. We have executed a detailed procedure for washing and cleaning the diffusers and can recommend suitable products on request. We also have our own laundry department where we test products and the best washing methods. You can also entrust the fabric diffusers to us for washing and cleaning.

## APPLICATION EXAMPLES

Food, engineering, automotive, chemical and textile industries, warehouses, schools, restaurants, temporary installations, freezing plants, kitchens, sport facilities, fitness centres, swimming pools, supermarkets, cinemas, theatres, tv studios, offices, laboratories, hospitals, clean areas, greenhouses, painting shops, transportation vehicles, stables, chicken hatcheries...



**PŘÍHODA s.r.o.**, Za Radnicí 476, Hlinsko 53901, EU-Czechia  
Tel.: +420 469 311 856 / Fax: +420 469 311 857  
E-mail: [info@přihoda.com](mailto:info@přihoda.com) / [www.přihoda.com](http://www.přihoda.com)